

User Manual

Walk Through Metal Detector: ZK-D2180S

Version: 1.0

Date: Feb. 2016

Contents

Notes.....	1
Product Specification.....	2
Installation Environment.....	3
Performance and Features.....	5
Parts.....	7
Installation	8
Control Panel	10
Detection Zones.....	11
Operation.....	12
Detection Adjustment.....	18
Brief Maintenance	20
Technical Parameters.....	21
Packing List	22
Warranty Card.....	23

Notes

PLEASE READ THE FOLLOWING INSTRUCTION CAREFULLY BEFORE OPERATION:



1. It's available for indoor use, if need use outdoor, please use canopy to protect it against rain.
2. Choose the smooth and stable installation place, don't touch the detector during security checking to avoid false alarm.
3. Make sure there's no big metal object or strong magnetic field around the detector within 2 meters.
4. Detector probe mustn't install in high temperature or wet circumstance.
5. Please wait 1 minute for its self-diagnosing when machine starts.
6. Do not disassemble the control units except the professional technician.
7. Follow the user manual and make sure the right wire connection when the device starts.

Product Specification

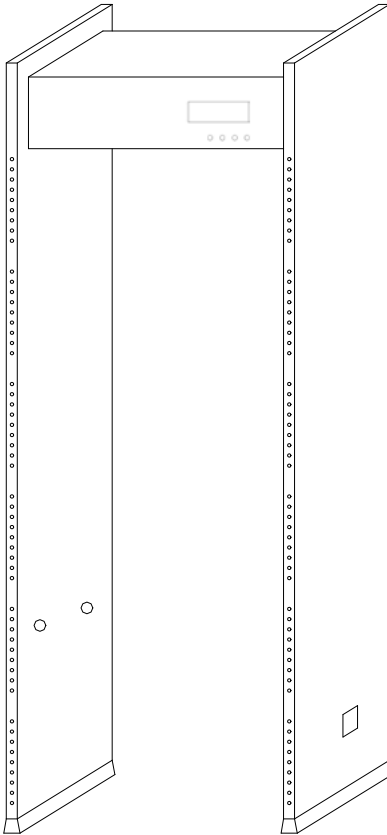

Walk Through Metal Detector is mainly used to check the metal items hidden on the body. When the passengers pass through the device, if they carried metals more than preset parameters value, the device would immediately alarms, and display alarm location, let the security guard find the people with the prohibited metal articles timely.

Installation Environment

1. Stationary Metallic Items

When installing walk through metal detector, it should stay away from the stationary or fixed bulk metal items 2 meters; otherwise it will affect the sensitivity, causing false alarm. Metal items such as: aluminum alloy / stainless steel doors and windows, with reinforced wall, etc.

2. Movable Metallic Items

The big metal items can be moved, should stay away from the device about 5 meters to avoid false alarm. Especially install the detector at factory gate or ground floor, need to pay attention to the effect of rolling gate, iron security doors, elevators and cars on the detector.

3. Floor Vibration

The floor should be flat and fixed, to avoid false alarm after installation by the movement of people walking or moving and shaking of metal objects.

4. Electromagnetic Radiation And Electromagnetic Interference

Because the device uses bilateral transceiver technology, therefore, any electromagnetic interference sources and electromagnetic radiation

source is not allowed to close the device, the recommended distance is 1~2 meters. The parameters of the distance are determined by the installation environment, and different installation environments with different parameters.

The electromagnetic interference sources and electromagnetic radiation sources as following:

Electrical Control Box, Radio Equipment, Interphone, Electronic Computer And Peripheral Equipment, Video Monitor, High Power Motor, Power Transformer, Ac Power Lines, Thyristor Control Circuit (High Power Switching Power Supply, Inverter Welder), Engine, Motor etc.

5. Side-By-Side Using

When installing the devices side by side, the distance between two walk through metal detectors can not be less than 50cm. Specific distance parameters according to the actual environment and the selection of the work frequency to adjust.

6. Cannot install the device in windy place

It would cause of false alarm if the device would slight swing in the wind.

Performance and Features

- **Accurate Positioning:** 18 overlapping network detection zone, bilateral transmit and receive, can be accurately positioned to detect objects, intuitive display of the target location.
- **Micro Processor Technology:** the scanning electromagnetic wave generated by the microcomputer control circuit, the scanning rate can be precisely controlled.
- **Sensitivity Adjustable:** each detection zone has 256 sensitivity levels (0 ~ 255). Preset metal size, you can exclude the coins, keys, jewelry, belt buckle etc.
- **Digital Pulse Technology:** digital signal processing and filtering system, has excellent anti-interference ability.
- **Password Protection:** only the correct password can change the sensitivity and other parameters. Password with four digital, can be set by the user.
- **Count Statistics:** pass count and alarm count.
- **Harmless to human body:** harmless to heart pacemaker, pregnant women, magnetic floppy disk, recording tapes etc.
- **Power Supply Security:** the power supply on the top of the control box, waterproof.

- **Waterproof Foot Cover:** not only can fixed the device, but also waterproof.
- **Waterproof:** using PVC synthetic material, special technology, waterproof, fireproof, shockproof.
- **Easy to install:** the system is integrated design, just 5 minutes to complete the installation or disassemble.

Parts

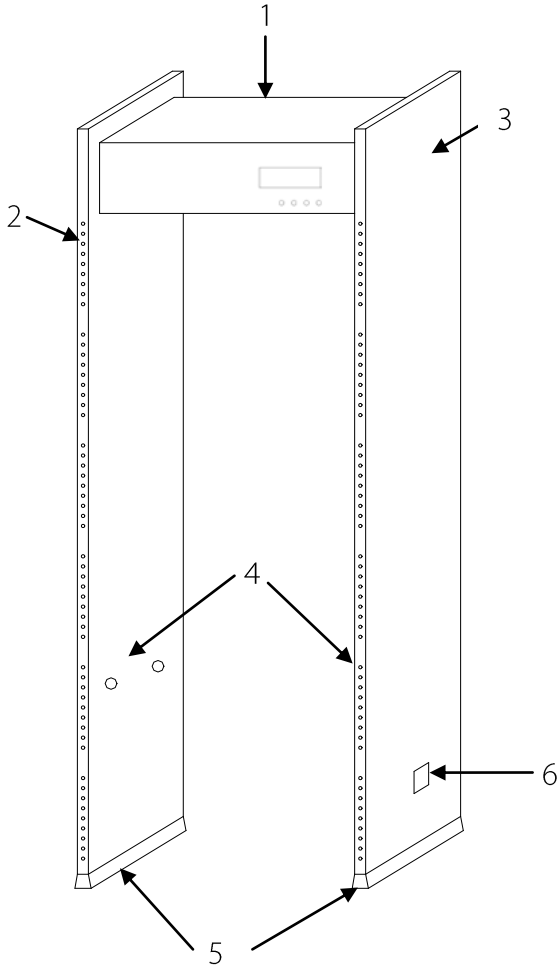

1. Control Unit Case

2. Alarm zone LED

3. Built-in Probe

4. Infrared Sensors

5. Waterproof Foot Cover

6. Power Line Interface

Installation

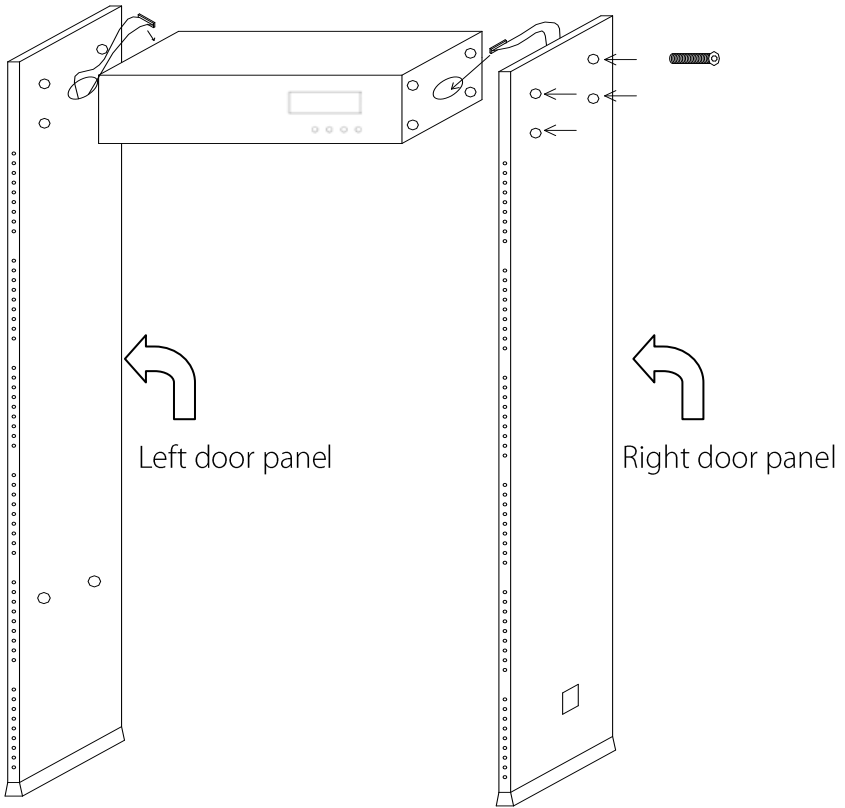

1. Remove the package of control unit and door panel.
2. Put the control unit case and door panels as above picture shown, then connect the left and right door panel with the control unit case by bolts and nuts. Tightening screws.
3. Probe line of the left and right door panel tight inserted into the motherboard corresponding socket respectively.

4. Install the screw on the control unit case cover.
5. Lift the walk through metal detector to the vertical position and move to the assigned position.
6. Plug power cable.

Control Panel

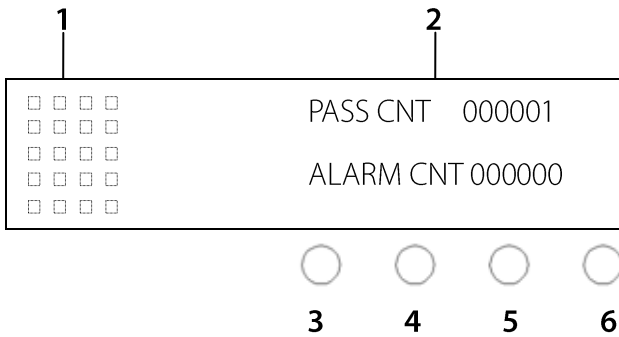

1. Alarm signal strength indicator (non alarm status: NO indicator.)
2. PASS CNT and ALARM CNT
3. ENTER: in the debugging process can be confirmed password, zone sensitivity. In addition, press “ENTER” for 5 seconds at the main interface (Showing PASS CNT and ALARM CNT), can restore the factory settings.

Factory settings: Menu password: 1234, Alarm time: 1 second
The sensitivity of zone 1 to zone 18: 255, Language: English

4. SETUP: change the parameters
5. SELECT: choose and enter to debugging interface. Switch to the next sensitivity setting and password digit etc.
6. RESET: Reset PASS CNT and ALARM CNT

Detection Zones

A. Standby indicators: Indicate standby working status

B. Alarm zones display

There are Eighteen unique sets of precise positioning LED evenly distribution on the door panels, means 18 detection zones (from bottom to top is zone 1-3, zone 4-6, zone 7-9, zone 10-12, zone 13-15, zone 16-18). If the metal reaches or exceeds preset value, the red LED alarm. If there are multiple alarm targets, the LED light of each target location would be lit and with sound alarm (mute except).

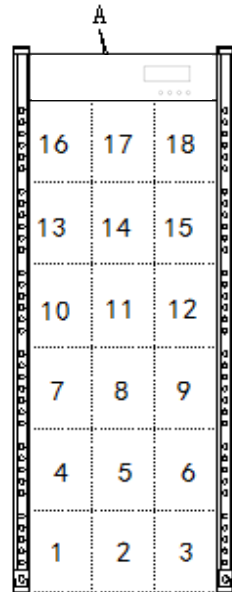

C. Infrared sensor

After connected power supply, the metal detector starts to work. When there is no person or object passes the device, the infrared sensors can effectively stop alarming to avoid false alarm. And accurate count passengers and alarm times.

Operation

Connect the power supply, it will displays Walk-through Metal Detector.

After 2 seconds into the working status, the operation method as follows:

A. Showing PASS CNT and ALARM CNT



B. If you want to entering menu to set the product parameters, press "SELECT" button and input the password. After entered the menu, you can adjust sensitivity, alarm time, quick settings, frequency, password, language, alarm volume etc.

a. Entering menu interface only when the password is correct. The initial password is 1234. For the new device, only need press "SELECT" — "ENTER".

INPUT PASSWORD interface as follows:

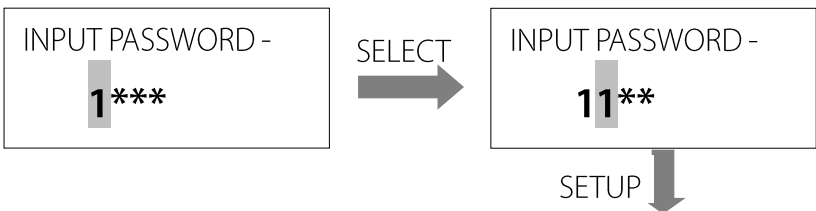

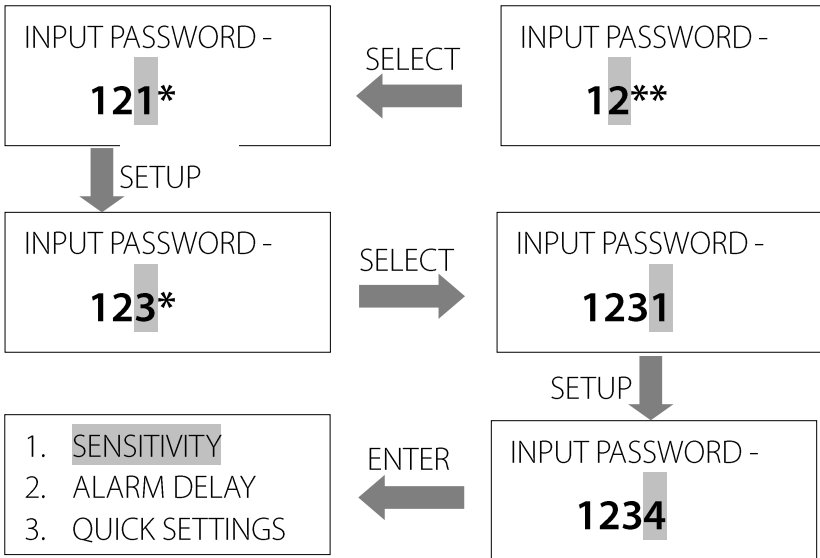

b. If the password was wrong, press any key to return, then input the correct password. If you have forgot the password, you can input the universal password "8888" to reset a new password.

1. SENSITIVITY

e.g. If you want to change zone 1-3 sensitivity from 220 to 230, change zone 4-6 sensitivity from 250 to 200, you can press "SETUP" to change the values, method as follows:

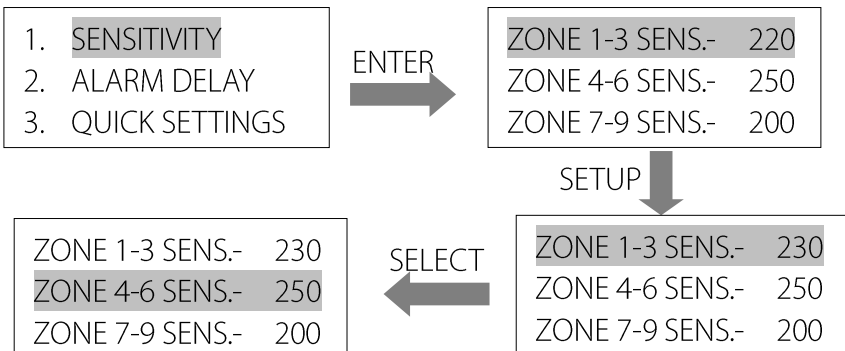

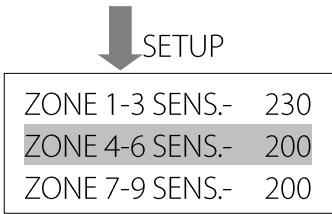

Sensitivity setting for ZONE 7-9, ZONE 10-12, ZONE 13-15, ZONE 16-18, are similar as above method. After adjusted, press “ENTER” to save all the settings, and back to the main menu.

2. ALARM DELAY

Under main menu interface, press “SELECT” to choose ALARM DELAY, then press “ENTER”. The alarm time is 1 second, 2 seconds and 3 seconds. If you want to change the alarm time from 1 second to 2 seconds, method as follows:

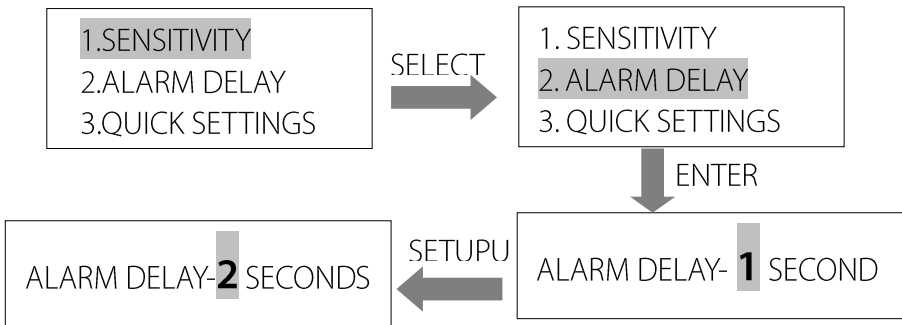

Press “ENTER” to save the settings, and back to the main menu.

3. QUICK SETTINGS

Under main menu interface, press “SELECT” to choose QUICK SETTINGS, then press “ENTER”.

Including the quick settings parameters of Electronics Factory, Hardware

Factory, Cable Factory, Court, Airport, Gymnasium, Night Club etc, which can be easily set the required parameters of the environmental.

Setting the application to Hardware Factory as follows:

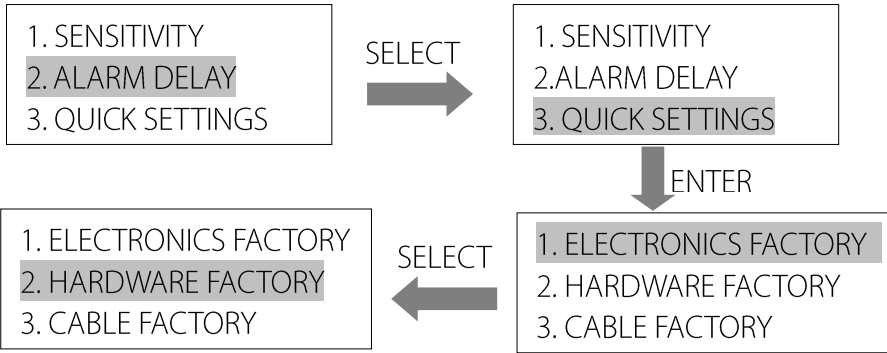

Press "ENTER" to save the settings, and back to the main menu.

4. FREQUENCY

Under main menu interface, press "SELECT" to choose FREQUENCY (FREQUENCY 1-12 are available), then press "ENTER". Change the frequency from frequency 1 to frequency 4 as follows:

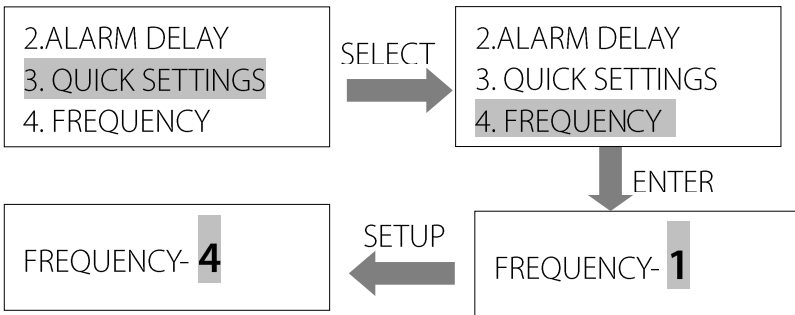

Press "ENTER" to save the settings, and back to the main menu.

5. CHANGE PASSWORD

Under main menu interface, press "SELECT" to choose CHANGE

PASSWORD, then press "ENTER".

e.g. Change the password to "5678" (for new machine, initial password is 1234) as follows:

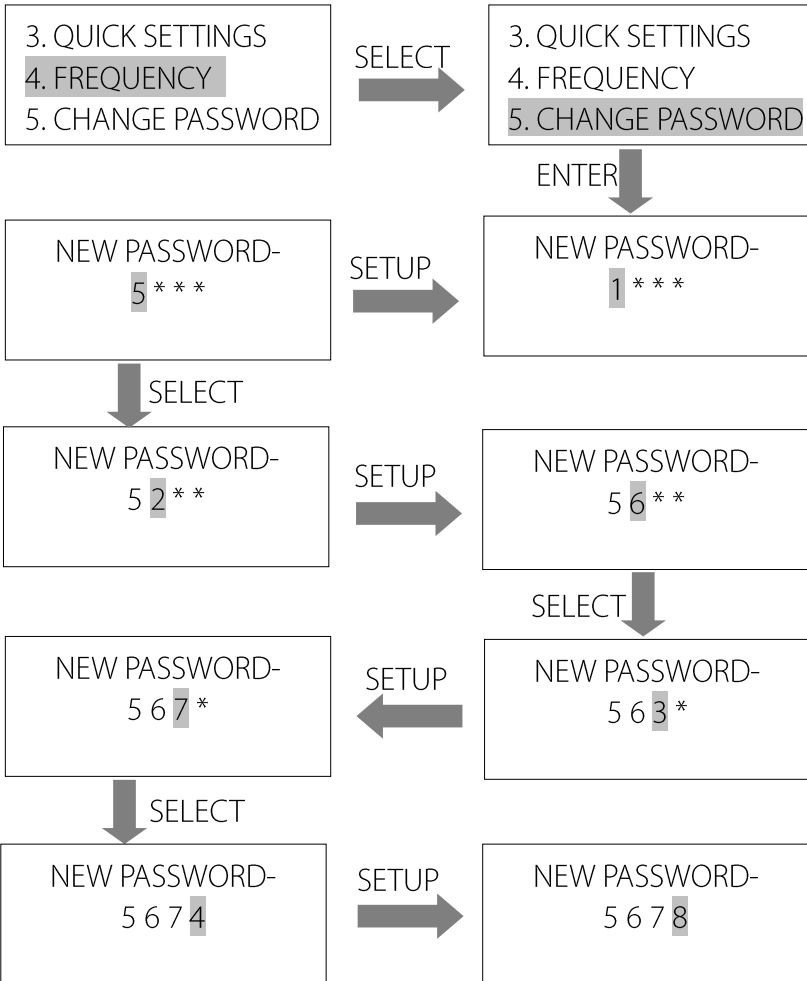

Press "ENTER" to save the settings, and back to the main menu.

In addition, if press "SELECT" for 5 seconds at the main interface (Showing PASS CNT and ALARM CNT), input password "2345" can setting

total sensitivity (5-50 adjustable, 5 is the highest total sensitivity).

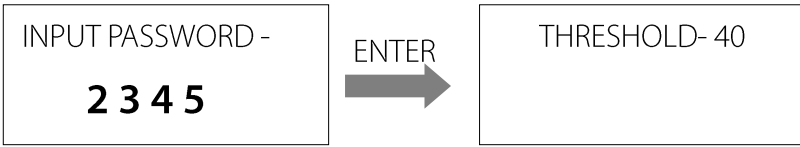

6. SELECT LANGUAGE

Under main menu interface, press “SELECT” to choose SELECT LANGUAGE, then press “ENTER”.

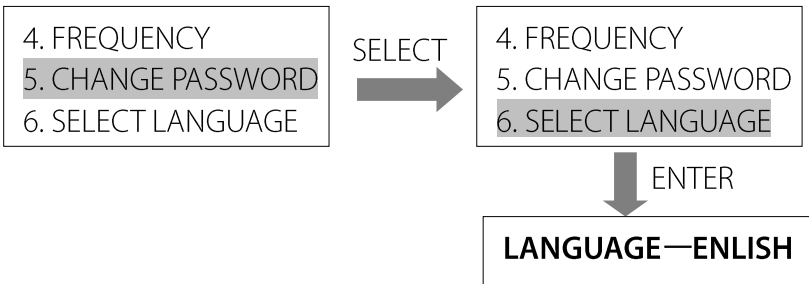

Press “ENTER” to save the settings, and back to the main menu.

7. VOLUME

Under main menu interface, press “SELECT” to choose VOLUME (HIGH/ NONE/ LOW), then press “ENTER”.

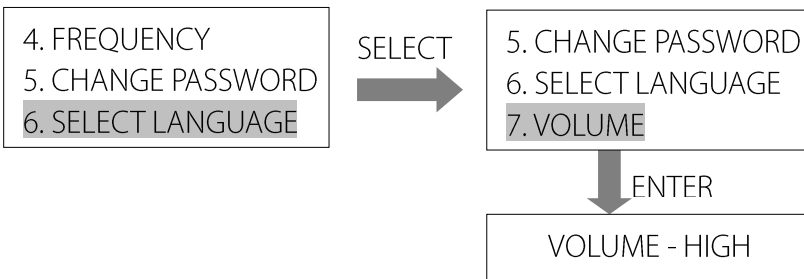

8. EXIT

Under main menu interface, press “SELECT” to choose EXIT, etc.

Detection Adjustment

1. The device must be in a stable status to achieve the best detection effect (refer to the "Installation Environment"), to check whether the device in a stable status, the steps as follows:
 - a. The device is not shaking after power ON for 1 minute.
 - b. The device would not alarm when the tester did not carry any metal items walk through the detector.

2. Excluding small portable metal objects such as rings, key, belt buckle, shoes and so on, according to the following steps to adjust:
 - a. Choose a small metal as the sample, such as keys.
 - b. Increasing the sensitivity, so that when the tester carry the sample and pass through the device, the detector would alarms.
 - c. Decreasing the sensitivity a little, carry the sample pass through the device again, if it still alarms, once again to reduce the sensitivity, until the device not alarm when the sample passed through.

Note: If you want to decrease the sensitivity in a certain zone, only have to adjust the sensitivity of relative zone. After finished the above

adjustment, the metal which smaller than the sample will not alarm, but the metal objects bigger than the sample can be detected accurately.

3. Traffic regulations:

- a. Draw a waiting line for 50cm away from the device, so that the passengers can line up and pass one by one.
- b. Before the passengers walk through the device, they should remove all the carried metal objects (such as keys, mobile phone, watch, coins, etc.), place on the side of security chute or a table, and pick it up after security checking.
- c. Passengers should line up one by one to pass the device, do not crowd, walk through with normal speed, can not intentionally rush or postponed, and do not crash the door panel.
- d. If the devices alarms when someone pass through, that means there are some metal objects were hidden in his body. The security guard can use a hand-held metal detector accurately detect the hidden position according to the alarm zones.

Brief Maintenance

1. Infrared sensor cannot count:
 - a. Check the probe cables were well connected with the door panels.
 - b. Check whether there are some infrared interferences beside the device, such as: infrared surveillance system, infrared remote control (when press button), outdoor sunlight, etc.
 - c. If both a and b are OK, please replace the Infrared sensor.

2. False alarm
 - a. After installation, if the device gives false alarms frequently, firstly, check the installation environment. Make sure there is no movable or stationary large metal objects around in 1.5 meters. if any, try to make the device away from the large metal objects. In addition, make sure the installation location no wind cause shaking.
 - b. If the false alarm not caused by the environment, please reduce the sensitivity of all zones.
 - c. Change the frequency
 - d. Change the installation location

Technical Parameters

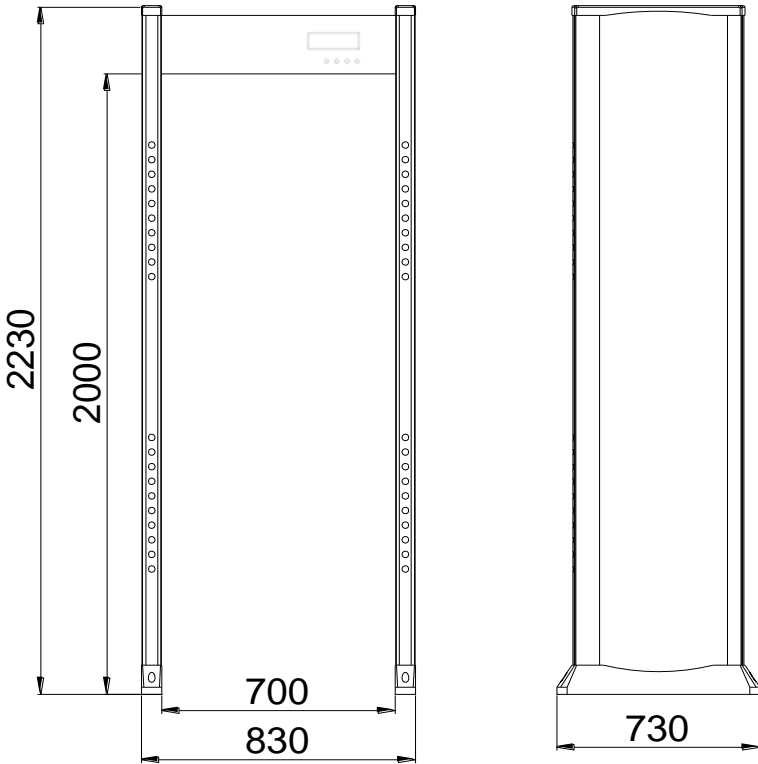

Input voltage: 100-240V, 50/60Hz

Power: <35W

Net weight: 67KG

Working temperature: 0 ~ 45°C

Sensitivity: 256 steps adjustable

Alarm: Visible and audible alarm

Inner Dimensions: 2000mm (High) x 700mm (Wide) x 605mm (Deep)

External Dimensions: 2230mm (High) x 830mm (Wide) x 730mm (Deep)

Packing List

Package should contain the following items:

- (1) L side panel 1set
- (2) R side panel 1set
- (3) Control Unit 1pc
- (4) User manual 1pc
- (5) Power cord 1pc
- (6) Threaded bolt 8pcs

Warranty Card

1. Please keep this card with reasonableness, and show it when maintaining it.
2. This card will be invalid if without the signature or stamp of the designated dealer.
3. This card will be regarded as invalid if it has not been filled in details three guarantees and acknowledgment of receipt. Please confirm whether the data filled in the three guarantees and acknowledgement of receipt is correct or not when purchasing it, and then hand it over to the dealer.
4. This card will not be supplied again if losing it.

Model Number	
ID	
Date Acquisition	
User	
Post Code	
Address	
User's Phone Number	
Fax	

Date of Maintenance	Record of Maintenance	Maintainer

